



Крепеж для
теплоизоляции

KEW TSD		<input checked="" type="checkbox"/>	<input checked="" type="checkbox"/>	<input checked="" type="checkbox"/>	<input type="checkbox"/>	<input type="checkbox"/>	<input type="checkbox"/>	<input type="checkbox"/>	<input type="checkbox"/>
KEW DSB									
KEW DSH		<input checked="" type="checkbox"/>	<input checked="" type="checkbox"/>	<input checked="" type="checkbox"/>	<input type="checkbox"/>	<input type="checkbox"/>	<input type="checkbox"/>	<input type="checkbox"/>	<input type="checkbox"/>
KEW DSHD									
KEW SSV									

- TSD

ETAG 004



KEW TSD

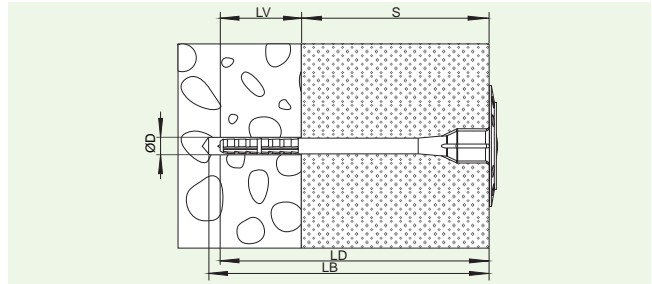

KEW TSD -

	ØD	LD	LB	LV	S	S
	8					

TSD 8 x 80	36309	8	80	90	40	-	40	200
TSD 8 x 100	36310	8	100	110	40	40	60	200
TSD 8 x 120	36311	8	120	130	40	60	80	200
TSD 8 x 140	36312	8	140	150	40	80	100	200
TSD 8 x 160	36313	8	160	170	40	100	120	200
TSD 8 x 180	36314	8	180	190	40	120	140	200
TSD 8 x 200	36315	8	200	210	40	140	160	200
TSD 8 x 220	36316	8	220	230	40	160	180	100
TSD 8 x 240	36317	8	240	250	40	180	200	100
TSD 8 x 260	36318	8	260	270	40	200	220	100
TSD 8 x 280	36319	8	280	290	40	220	240	100
TSD 8 x 300	36320	8	300	310	40	240	260	100



KEW TSD -

(ETAG 004)*

TSD 8 x 80N	35027	8	80	90	40	-	40	200
TSD 8 x 100N	35028	8	100	110	40	40	60	200
TSD 8 x 120N	35029	8	120	130	40	60	80	200
TSD 8 x 140N	35030	8	140	150	40	80	100	200
TSD 8 x 160N	35031	8	160	170	40	100	120	200
TSD 8 x 180N	35032	8	180	190	40	120	140	200
TSD 8 x 200N	35033	8	200	210	40	140	160	200
TSD 8 x 220N	35034	8	220	230	40	160	180	100
TSD 8 x 240N	35035	8	240	250	40	180	200	100
TSD 8 x 260N	35036	8	260	270	40	200	220	100
TSD 8 x 280N	35037	8	280	290	40	220	240	100
TSD 8 x 300N	35038	8	300	310	40	240	260	100

(Ø 62)

ETAG

004

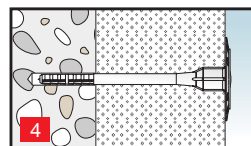
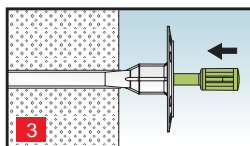
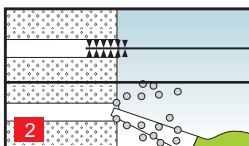
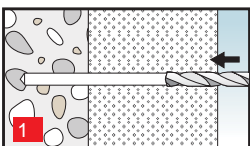

Крепеж для
Термодомов

- TSD



KEW TSD 8

C 20 / 25 []	0,5
C 12 / 15 []	0,75
(. DIN 105) Mz []	0,6
(. DIN 106) Ks []	0,8
(EN 1520) []	0,4
(. DIN 18152) V []	0,4
Smin []	100
Cmin []	100
h []	100

Крепёж для теплоизоляции

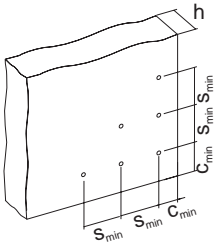

- TSD KN



T
KEW TSD KN

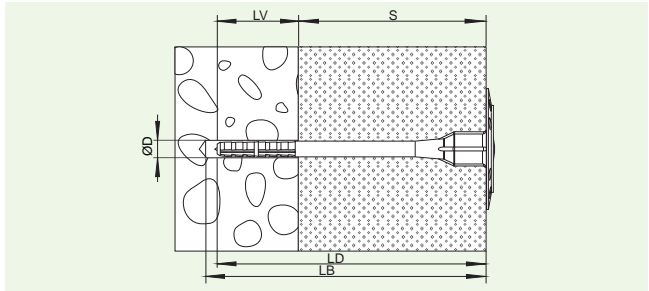

KEW TSD KN -

*

	ØD	LD	LB	LV	S	S
	Ø					

TSD 8 x 80 KN	35456	8	80	90	40	-	40	200
TSD 8 x 100 KN	35457	8	100	110	40	40	60	200
TSD 8 x 120 KN	35458	8	120	130	40	60	80	200
TSD 8 x 140 KN	35459	8	140	150	40	80	100	200
TSD 8 x 160 KN	35460	8	160	170	40	100	120	200
TSD 8 x 180 KN	35461	8	180	190	40	120	140	200



Крепеж для
Термопанели

(Ø 62)

	B25
TSD 8 KN	1,1

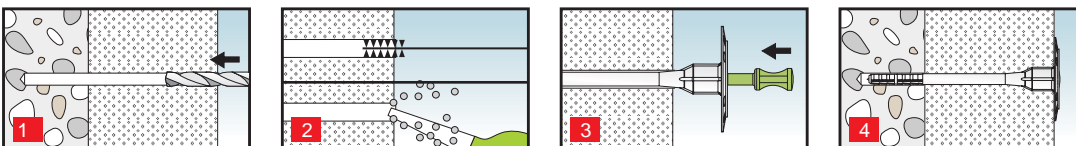

- DSB

ETAG 004

KEW TSD



KEW DSB

- ;
- (KEW DSH) (KEW TSD).



KEW DSB -

øS	
ø	

DSB 90	35396	90	200
DSB 110	35397	110	200
DSB 140	35398	140	200

(. 62-63)

Крепёж для теплоизоляции

- SSV



KEW SSV



KEW SSV -

SSV 30	36719	30 mm	100	1600
--------	-------	-------	-----	------



KEW MTS -

MTS 6	36197	ASH 3	ND 6x60 Z	75
			SSV 3	10
MTS 8	36193	ASH 3	ND 8x80 Z	75
			SSV 3	10



1
2 KEW DSH

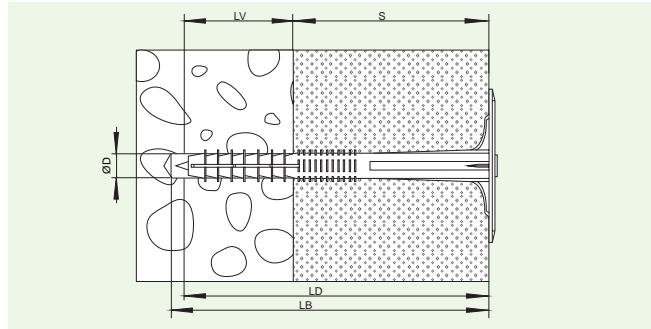

KEW DSH -

	ØD	LD	LB	LV	S
Ø	10				
DSH 10 x 90 S	33997	10	90	100	40 40 - 50
DSH 10 x 110 S	33998	10	110	120	40 60 - 70
DSH 10 x 130 S	33999	10	130	140	40 80 - 90
DSH 10 x 140 S	34000	10	140	150	40 90 - 100
DSH 10 x 150 S	34001	10	150	160	40 100 - 110
DSH 10 x 160 S	34002	10	160	170	40 110 - 120
DSH 10 x 170 S	34003	10	170	180	40 120 - 130
DSH 10 x 190 S	34004	10	190	200	40 130 - 150
DSH 10 x 220 S	35047	10	220	230	55 150 - 165
DSH 10 x 240 S	35048	10	240	250	55 170 - 185
DSH 10 x 260 S	35049	10	260	280	55 190 - 205



KEW SN gz -

SN gz 5 x 95	35100	5	95	250
SN gz 5 x 115	35101	5	115	250
SN gz 5 x 135	35102	5	135	250
SN gz 5 x 145	35103	5	145	250
SN gz 5 x 155	35104	5	155	250
SN gz 5 x 165	35105	5	165	250
SN gz 5 x 175	35106	5	175	250
SN gz 5 x 195	35107	5	195	250
SN gz 5 x 225	35060	5	225	125
SN gz 5 x 245	35061	5	245	125
SN gz 5 x 265	35062	5	265	125

*

	B25	MZ15	G4
DSH10 mm	0,7	0,8	0,6

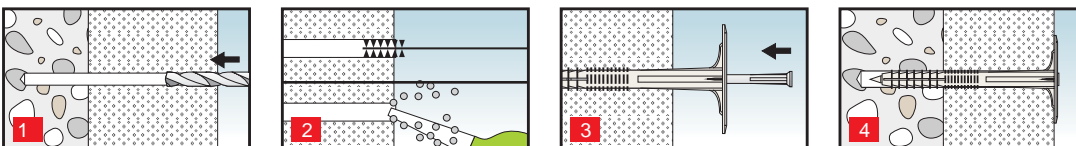

Крепеж для
Термопанели

- DSH K

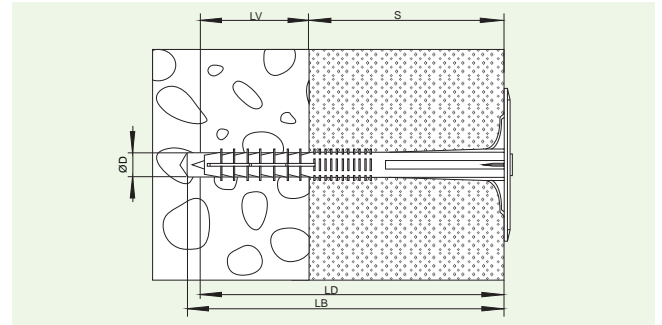
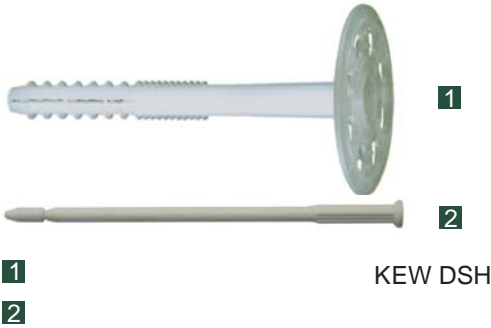

KEW DSH -

	ØD	LD	LB	LV	S
	Ø				

DSH 10 x 90 K	33997	10	90	100	40	40 - 50	250
DSH 10 x 110 K	33998	10	110	120	40	60 - 70	250
DSH 10 x 130 K	33999	10	130	140	40	80 - 90	250
DSH 10 x 140 K	34000	10	140	150	40	90 - 100	250
DSH 10 x 150 K	34001	10	150	160	40	100 - 110	250
DSH 10 x 160 K	34002	10	160	170	40	110 - 120	250
DSH 10 x 170 K	34003	10	170	180	40	120 - 130	250
DSH 10 x 190 K	34004	10	190	200	40	130 - 150	250



KEW KN -

KN gz 5,5 x 95	35063	5,5	95				250
KN gz 5,5 x 115	35064	5,5	115				250
KN gz 5,5 x 135	35065	5,5	135				250
KN gz 5,5 x 145	35066	5,5	145				250
KN gz 5,5 x 155	35067	5,5	155				250
KN gz 5,5 x 165	35068	5,5	165				250
KN gz 5,5 x 175	35069	5,5	175				250
KN gz 5,5 x 195	35070	5,5	195				250

*

	B25	MZ15	G4
DSH10 mm	0,7	0,8	0,6

8 (DIN 1102).

(Ø60)

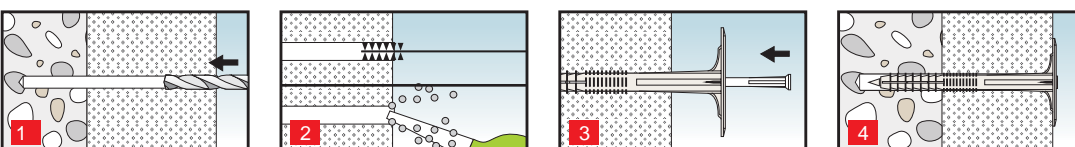

- DSHD



KEW DSHD

KEW DSHD

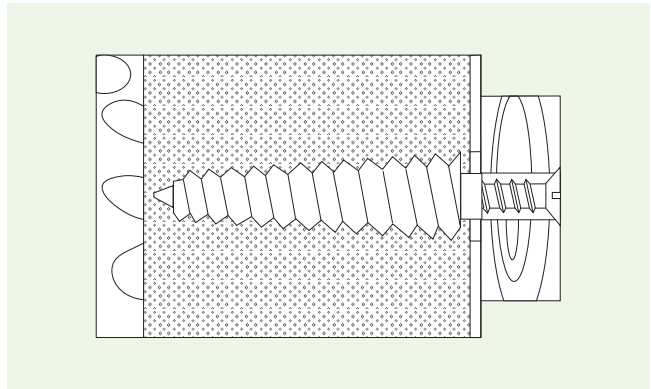

Кремаж для
Термошпильки



KEW DSHD -

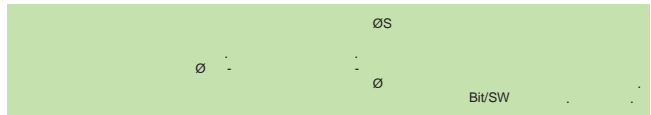

DSHD 50	36419	20	50	40	M4 / 4,0	KS	9	50	400
DSHD 85	36420	30	85	50	M8 / 8,0	SW	17	20	160

*

DSHD 50	0,04	0,12
DSHD 85	0,08	0,20

